

目 录

一、运输作业组织与管理模块..... 2

二、仓储与配送作业组织与管理模块..... 34

三、国际物流作业组织与管理模块..... 150

四、 快递物流作业组织与管理模块.....	213
-----------------------	-----

湖南商务职业技术学院物流管理专业学生技能考核题库

一、运输作业组织与管理模块

○

○

○

--	--	--

○

○

--	--	--	--	--

() 任务描述

- :
-
-



<input type="checkbox"/> <input type="checkbox"/>				<input type="checkbox"/> <input type="checkbox"/>				
<input type="checkbox"/> <input type="checkbox"/>								
						<input type="checkbox"/> <input type="checkbox"/> <input type="checkbox"/> <input type="checkbox"/>		



() 任务描述:

-
-
-



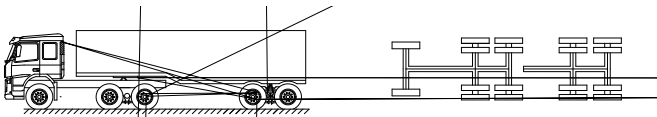

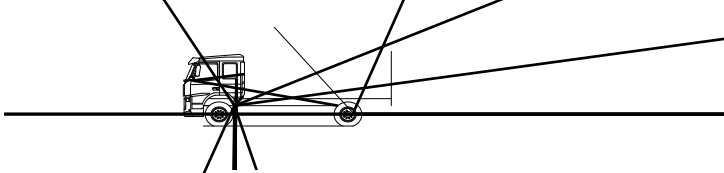
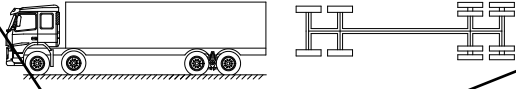

() 任务描述:



○

○

○

○

○

() 任务描述



D

<input type="checkbox"/> <input type="checkbox"/>			<input type="checkbox"/> <input type="checkbox"/>						
<input type="checkbox"/> <input type="checkbox"/>									
						<input type="checkbox"/> <input type="checkbox"/> <input type="checkbox"/> <input type="checkbox"/>			





2

3

4

() 任务描述



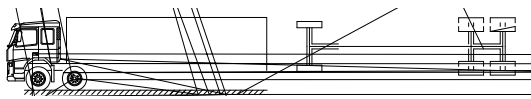
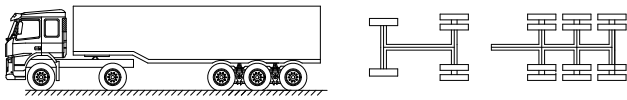
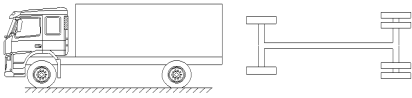



() 任务描述

-
-
-
-
-

() 任务描述

()

()

)	()		

()

()

()

()

()

○

()				

Sailing Schedule from : Shenzhen,Shenzhen,Guangdong,China

To : Los Angeles,Los Angeles,CA,United States

Origin City : Shenzhen,Shenzhen,Guangdong,China

Destination City : Los Angeles,Los Angeles,CA,United States

CY/DOOR

CY/DOOR

序列号	航线	船名	航次	截关时间	装货港	预计离港时间	实际离港时间	卸货港
1	YPSW	YM UNISON	59E	2016-04-22 17:00	Yantian	2016-04-25		Los Angeles
2	SEA	NORTHERN JAVELIN	002E	2016-04-23 12:00	Yantian	2016-04-27		Long Beach
3	AAS2	CMA CGM LIBRA	095TXE	2016-04-25 16:00	Yantian	2016-04-28		Long Beach
4	YPSW	YM UBIQUITY	22E	2016-04-29 17:00	Yantian	2016-05-02		Los Angeles
5	SEA	C SCL PUSAN	117E	2016-04-30 12:00	Yantian	2016-05-04		Long Beach
6	AAS2	CMA CGM COLUMBA	097TXE	2016-05-02 16:00	Yantian	2016-05-05		Long Beach
7	SEA	COSCO NINGBO	069W	2016-05-06 11:00	Yantian	2016-05-08		Long Beach
8	YPSW	YM JIREBY...	50E	2016-05-06 17:00	Yantian	2016-05-09		Los Angeles
9	SEA	COSCO EXCELLENCE	027E	2016-05-07 12:00	Yantian	2016-05-11		Long Beach
10	AAS2	CMA CGM CENTAURUS	099TXE	2016-05-09 16:00	Yantian	2016-05-12		Long Beach
11	YPSW	YM MASCULINITY	32E	2016-05-13 17:00	Yantian	2016-05-16		Los Angeles
12	SEA	HONG KONG BRIDGE	039E	2016-05-14 12:00	Yantian	2016-05-18		Long Beach
13	AAS2	CMA CGM THALASSA	101TXE	2016-05-16 16:00	Yantian	2016-05-19		Long Beach



干货箱



	箱体内部尺寸			箱体内容积及载重量		箱门开度尺寸	
	L	W	H	Cu	P	W	H
20'	5898	2352	2393	33.2	21740/28230#	2340	2280
40'	12032	2352	2393	67.7	26630	2340	2280
HC	12032	2352	2698	76.3	26520	2340	2585

冷藏箱



	箱体内部尺寸			箱体内容积及载重量	
	L	W	H	Cu	P
20'	5444	2284	2267	28.5	21135/27160#
40'	11583	2284	2250	58.7	26580
HC	11583	2286	2556	67.9	26380

开顶箱



	箱体内部尺寸			箱体内容积及载重量	
	L	W	P	Cu	P
20'	5900	2330	2337	32.6	21740
40'	12025	2330	2337	65.8	26410

○

○

() 实施条件

() 考核时量

() 评分细则

1

() 任务描述



		<input type="checkbox"/>	<input type="checkbox"/>	<input type="checkbox"/>	<input type="checkbox"/>

<input type="checkbox"/> <input type="checkbox"/> <input type="checkbox"/> <input type="checkbox"/>							



() 实施条件

() 考核时量

() 评分细则

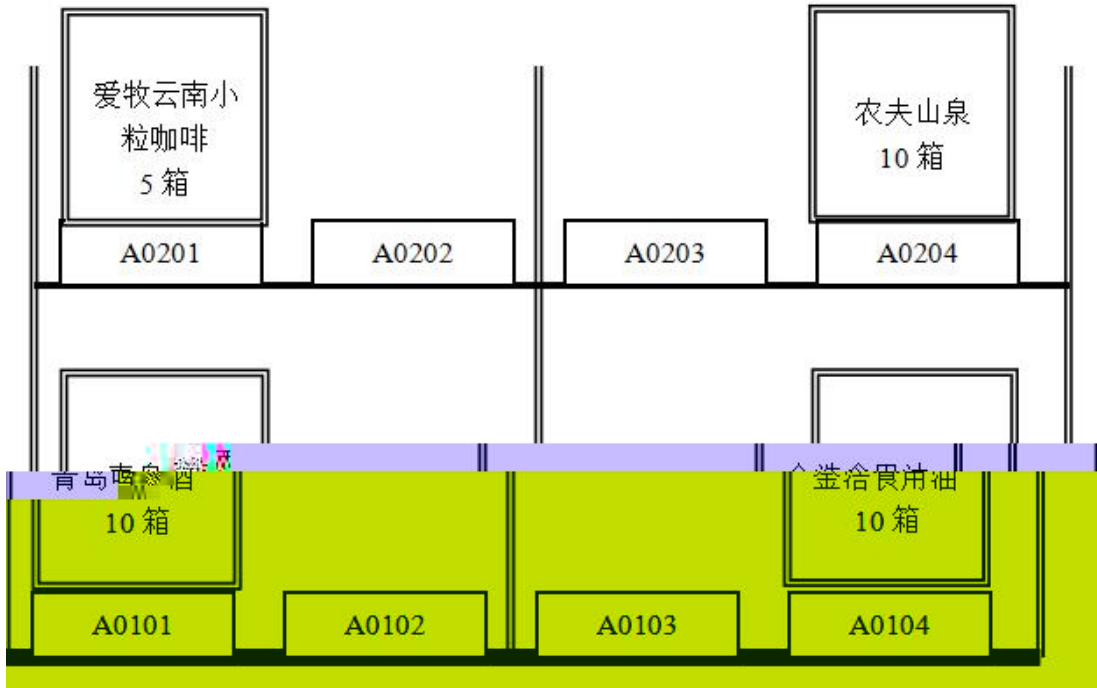

产品运输单

-
-
-
-
-
-
-
-

80				

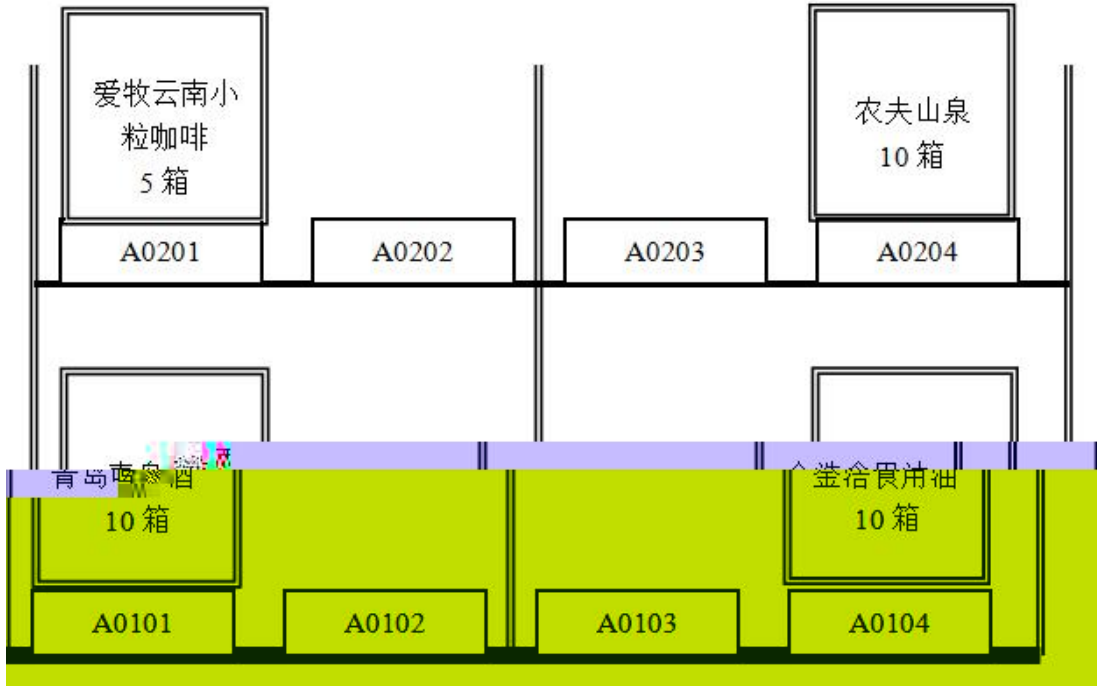

产品运输单

-
-
-
-
-
-
-
-

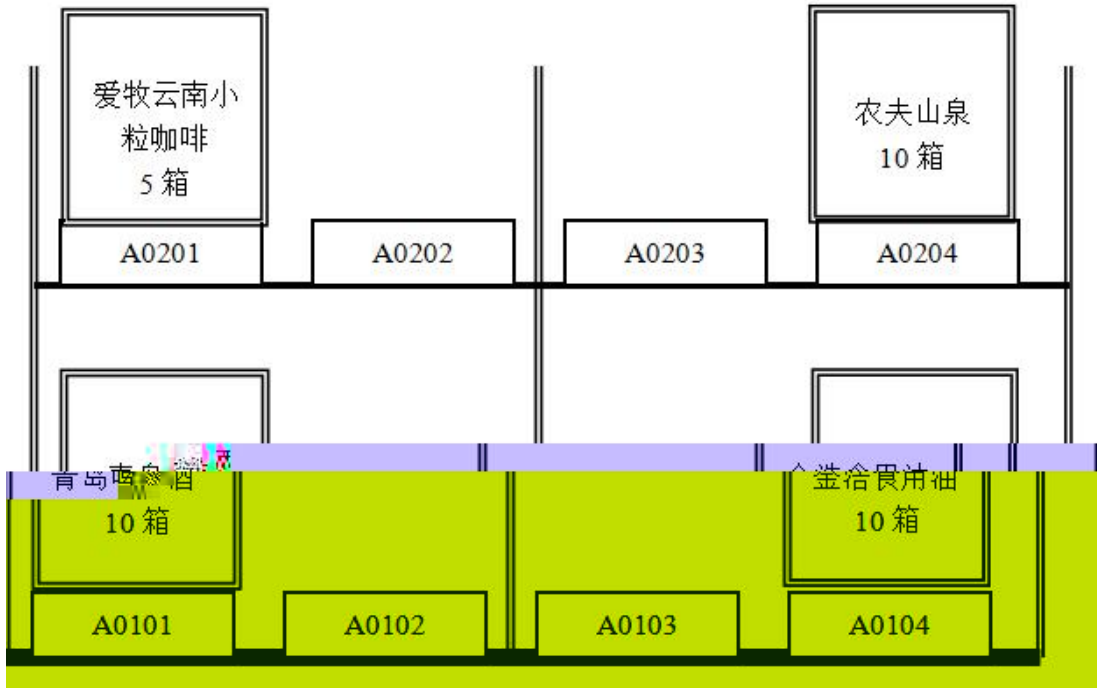

产品运输单

-
-
-
-
-
-
-
-

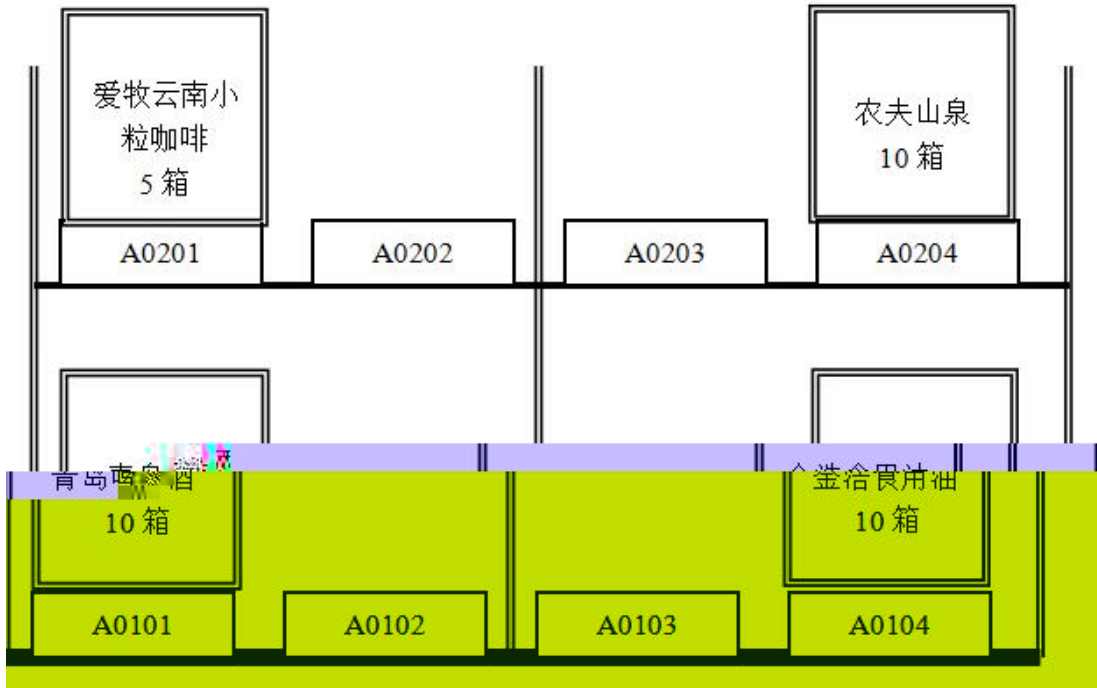

产品运输单

-
-
-
-
-
-
-
-

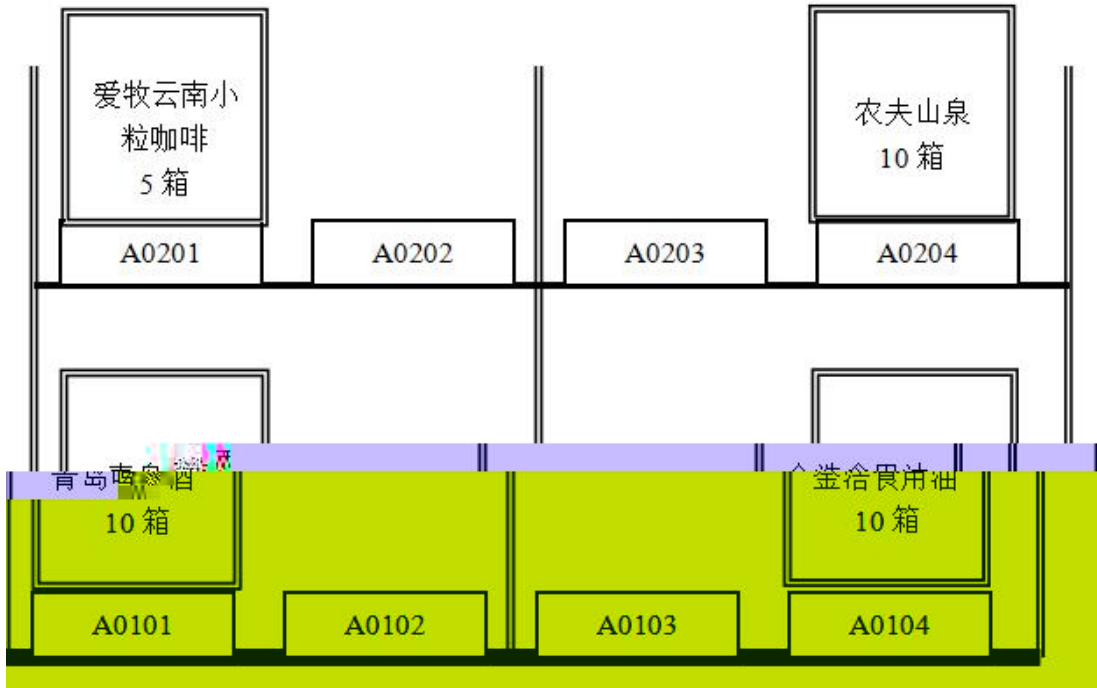

产品运输单

○

○

○

○

○

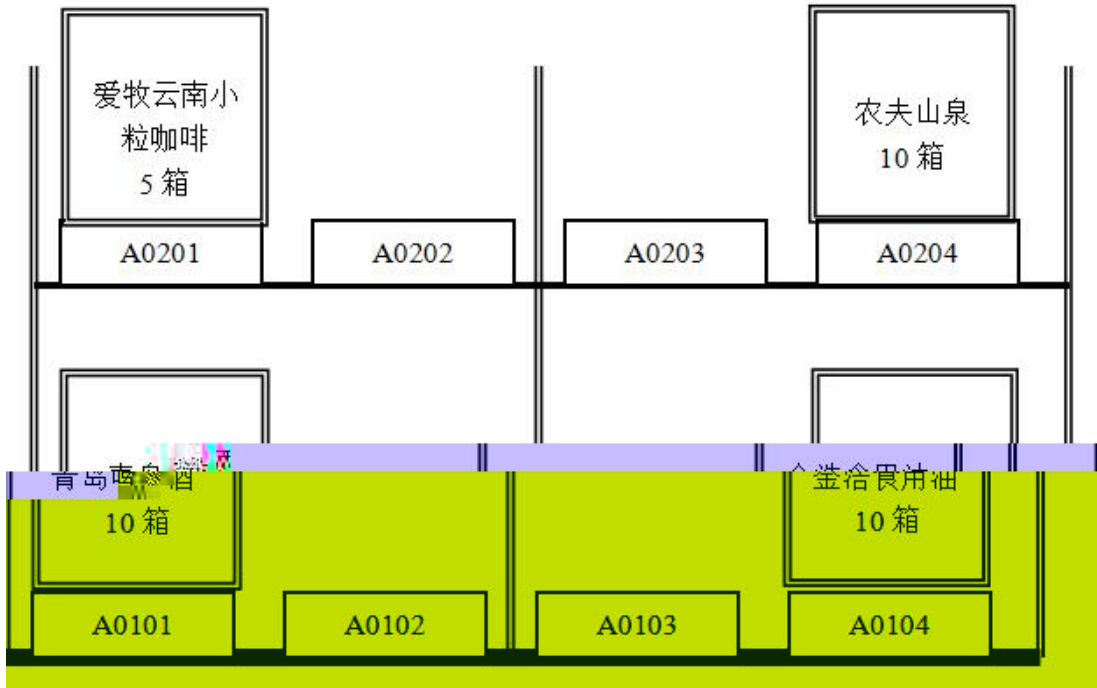

产品运输单

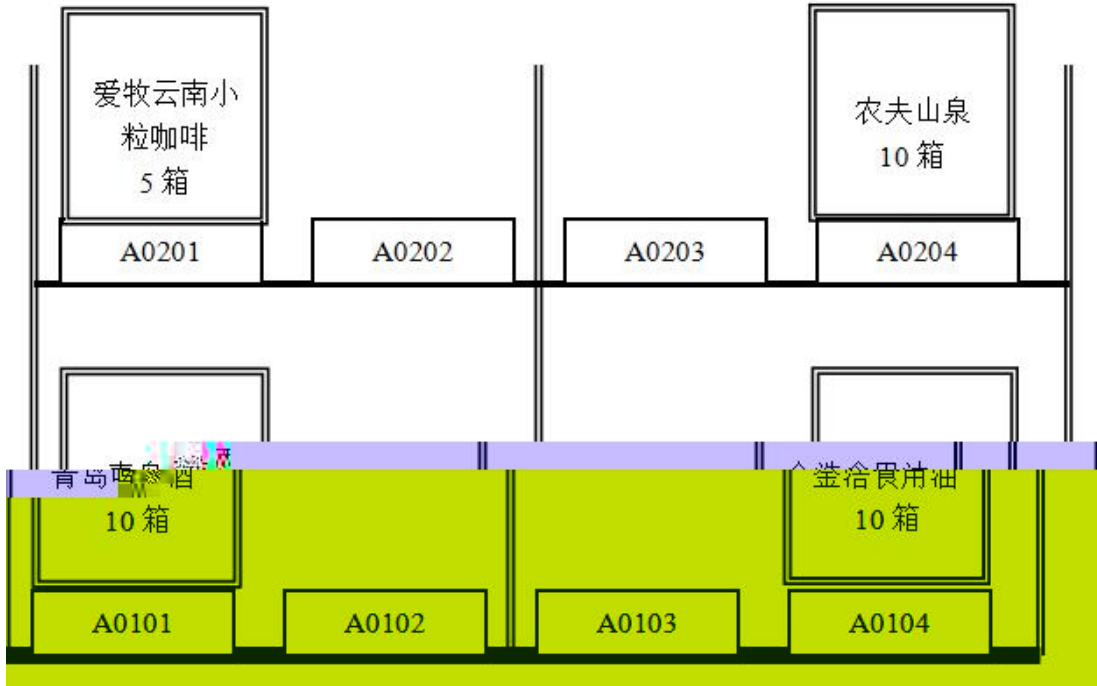

产品运输单

-
-
-
-
-
-
-
-
-

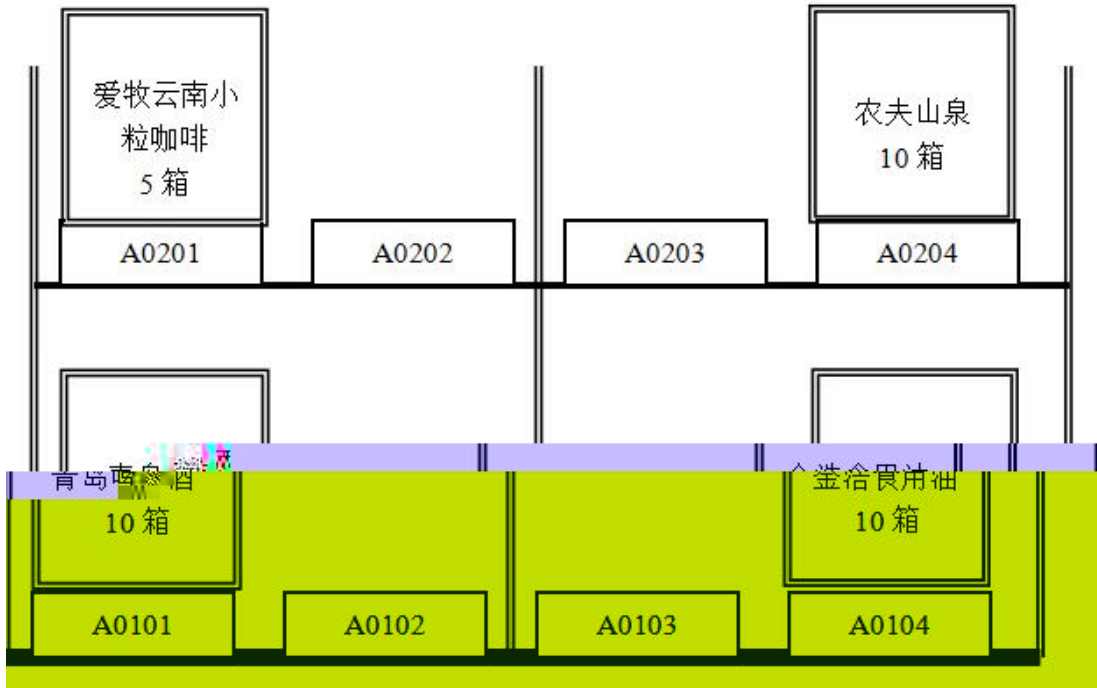

产品运输单

-
-
-
-
-
-
-
-
-

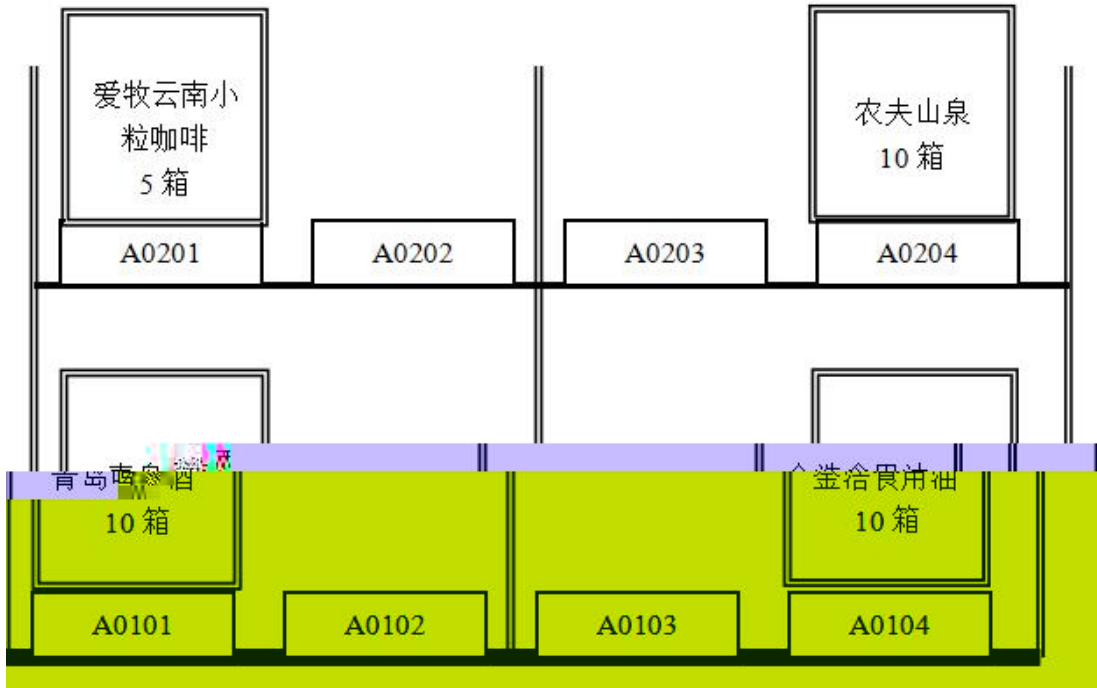

产品运输单

-
-
-
-
-
-
-
-

7€

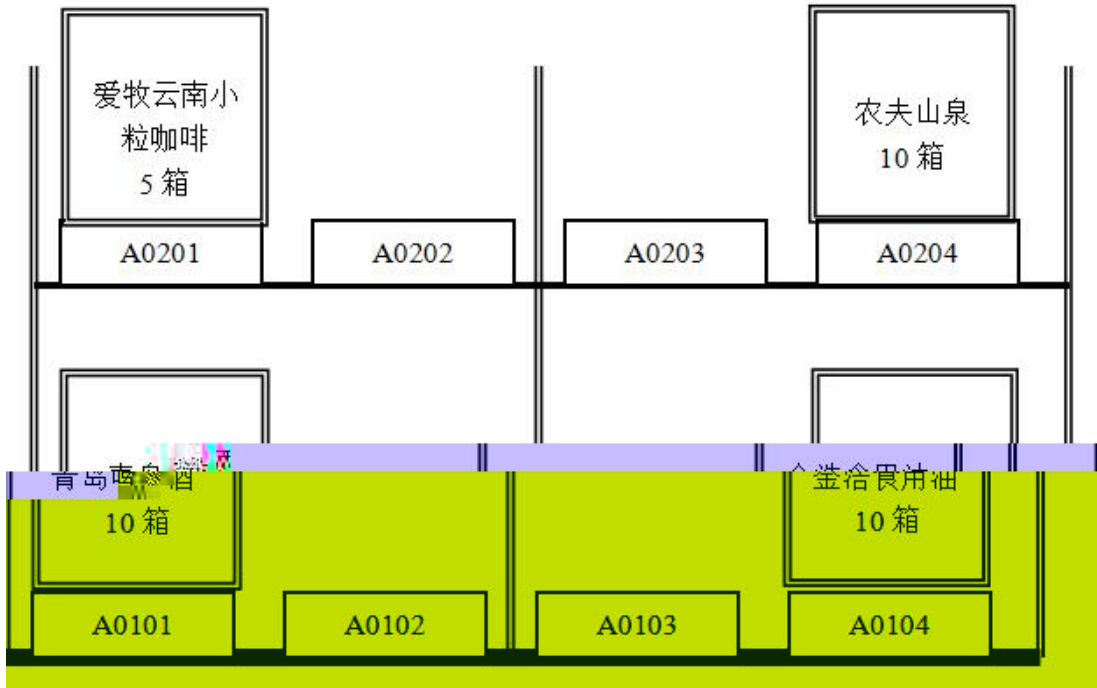

产品运输单

-
-
-
-
-
-
-
-

○

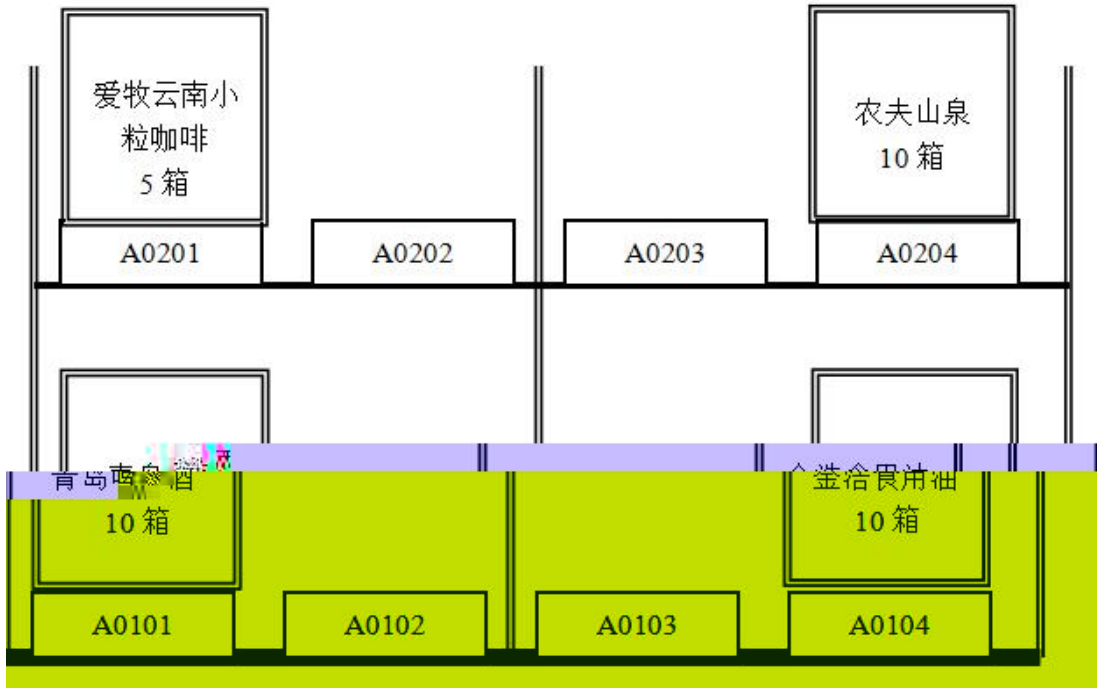



--	--	--	--	--	--

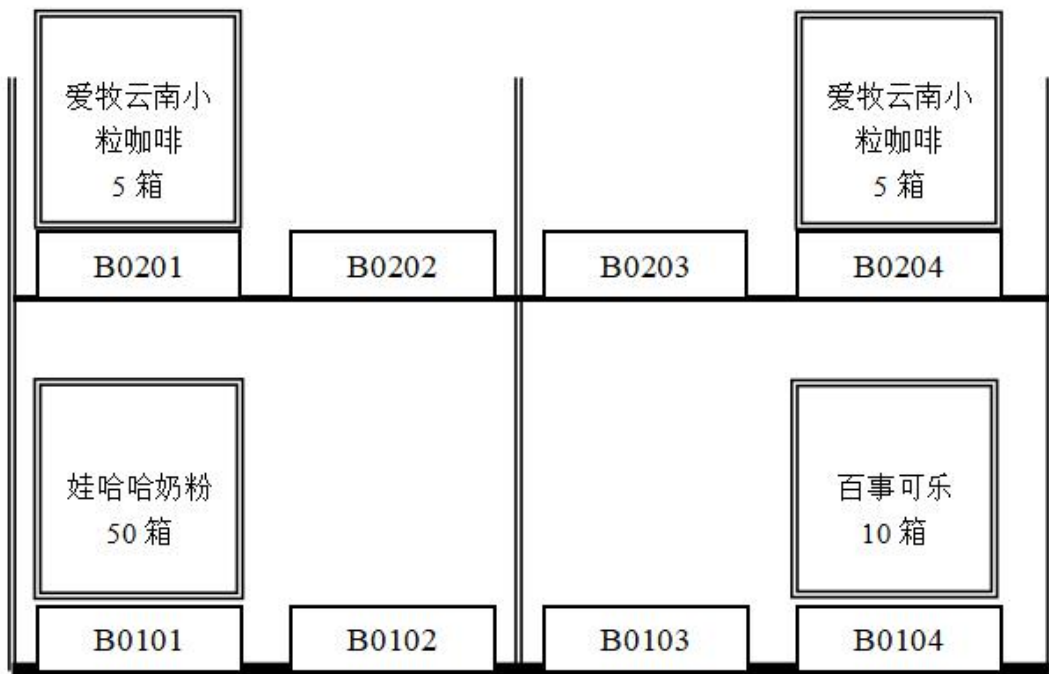
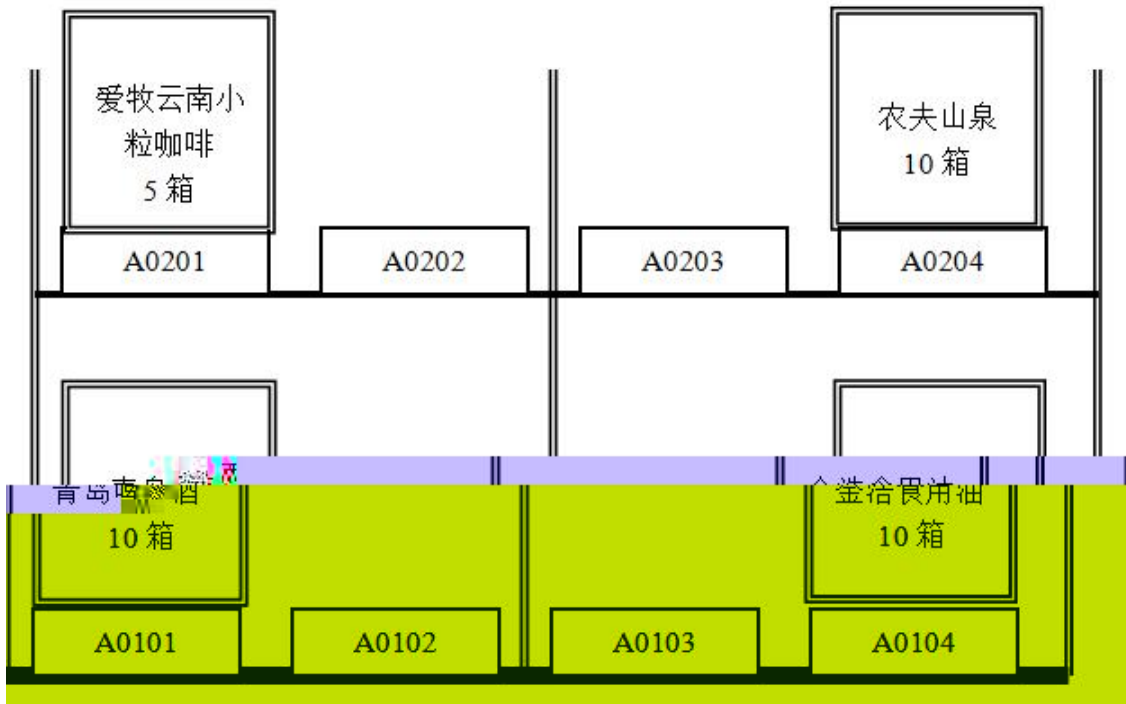

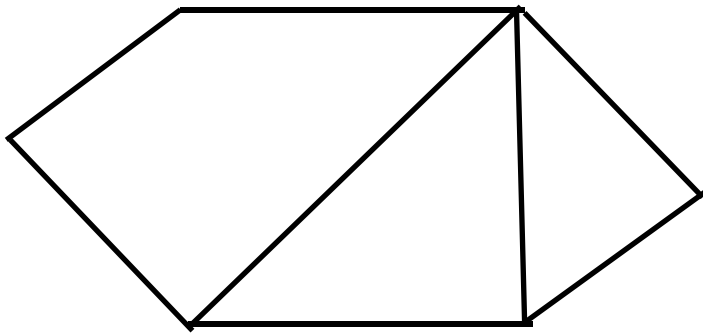

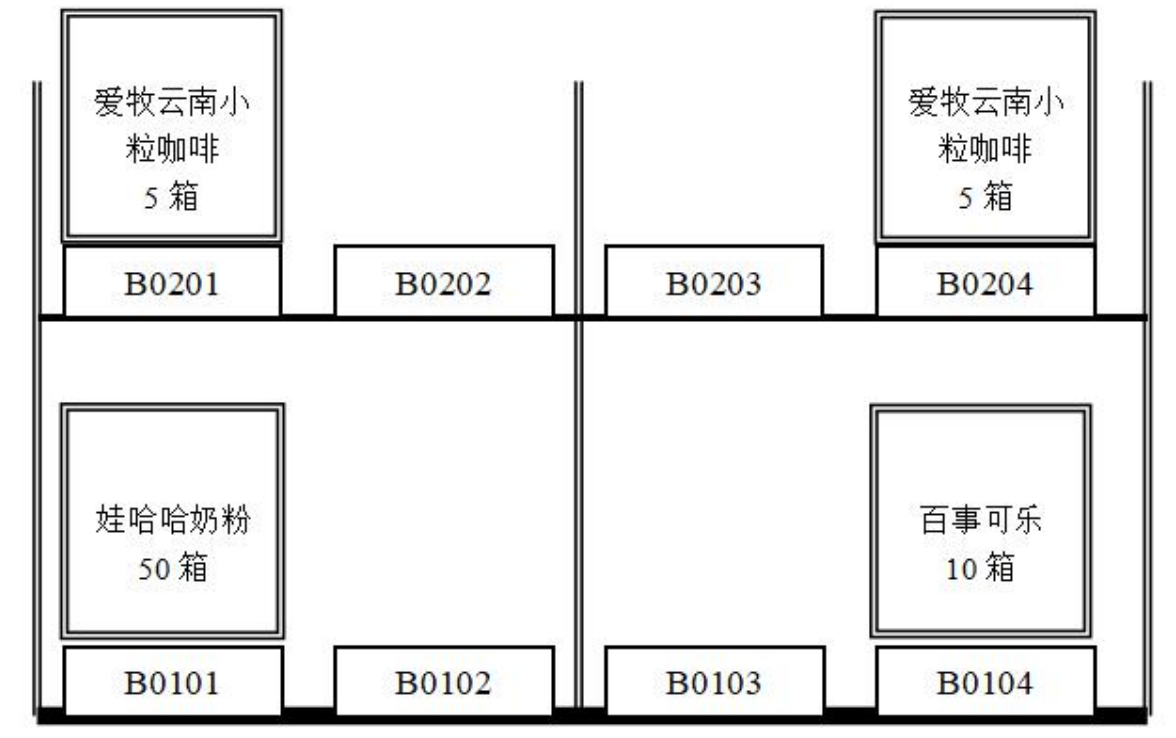
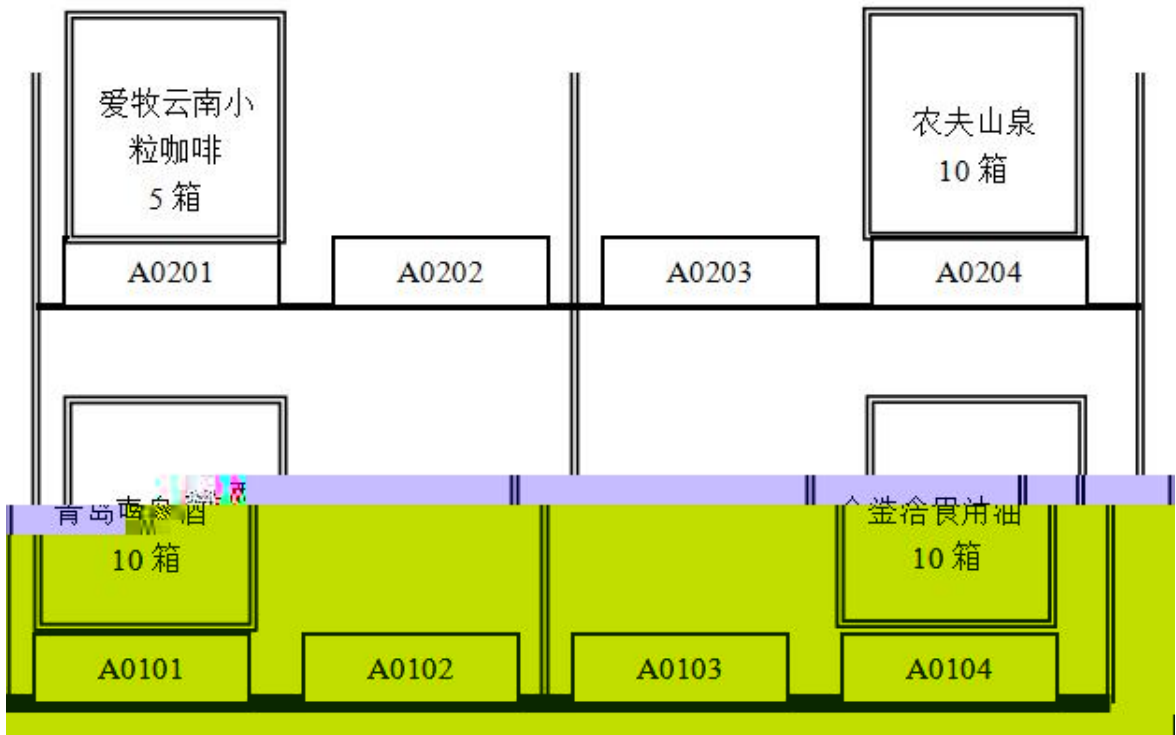



1



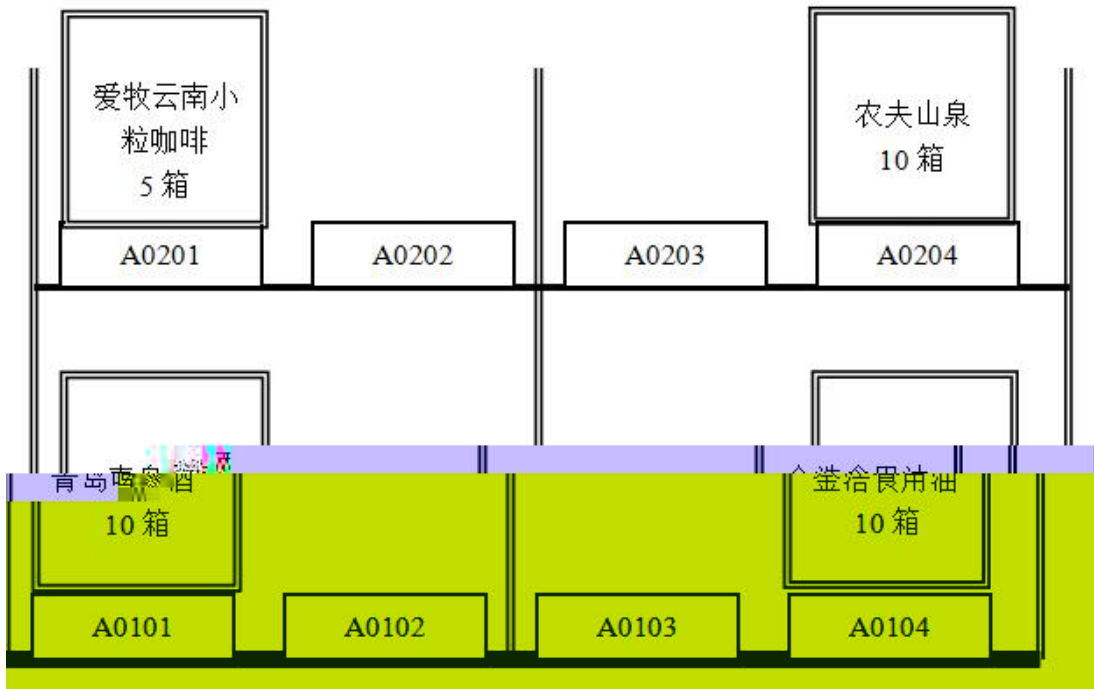



1

--	--	--	--	--	--

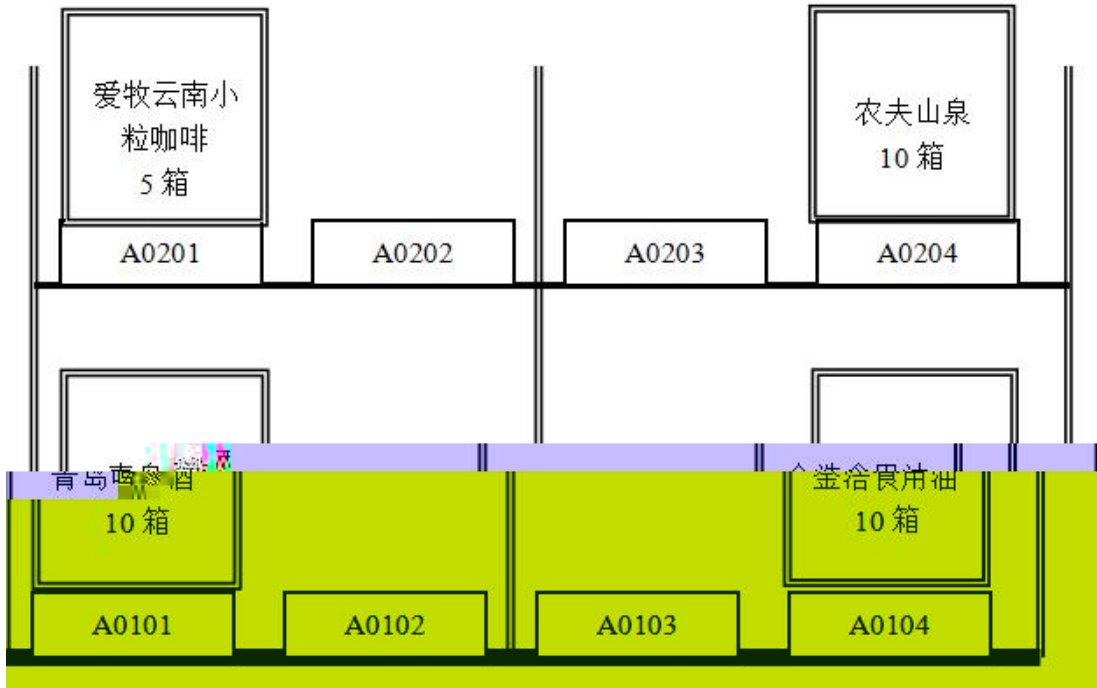



○

○

○

○

○

○

○

○

--	--

○

○

三、国际物流作业组织与管理模块

○

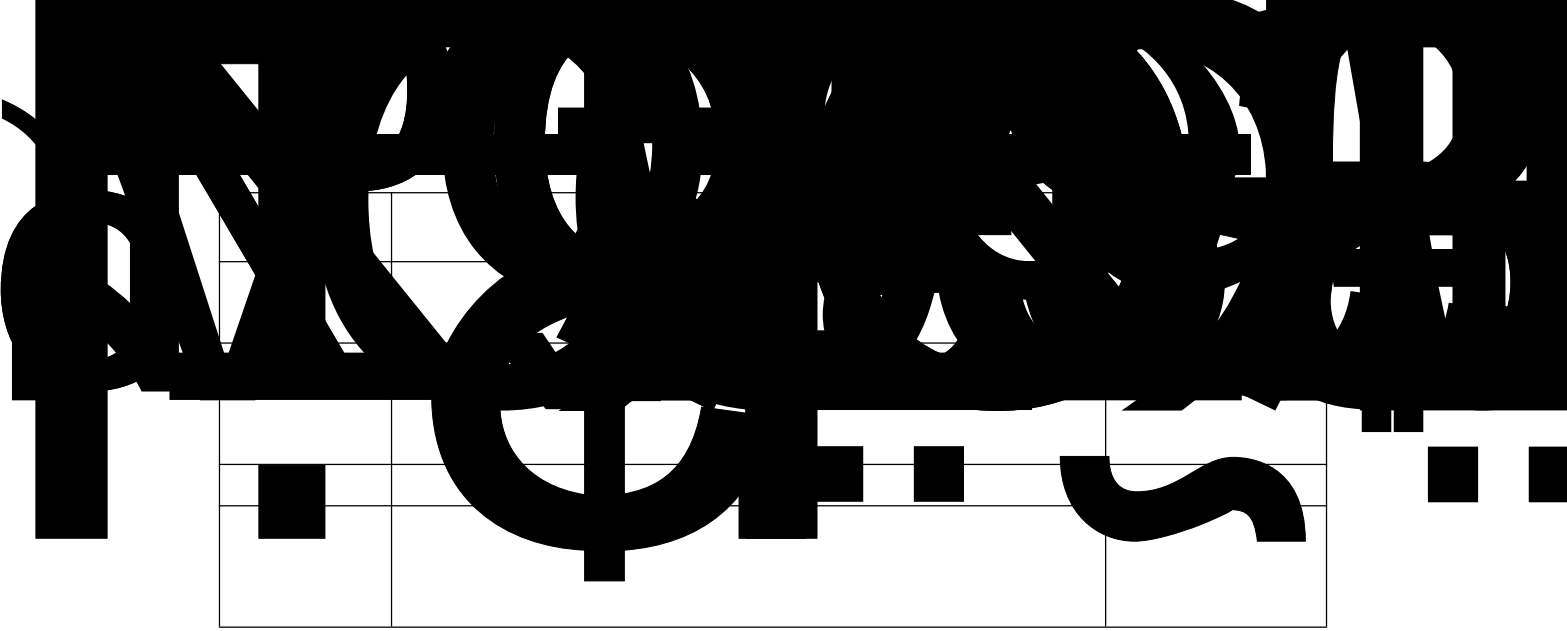



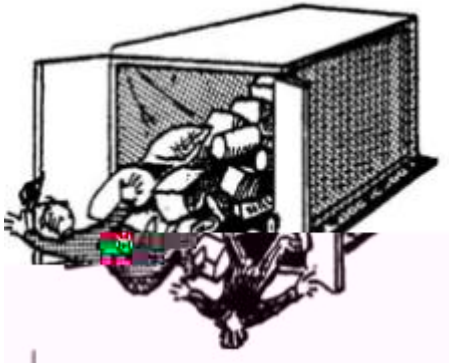
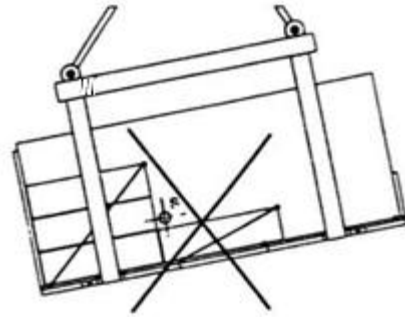

○

船公司 Carrier	船名/航次 Voyage	服务代码 Service	航线 Lane	装船港/卸船港 Load/Unload Port	启-达日期 ETD-ETA	天 Day	挂港
MSC 地中海航运	MASTER 74087		中国-东南亚	HONG KONG 香港 KAOHSIUNG 高雄	02/25(二) 03/15(六)	18	香港 高雄
NYK 日本邮船	ITALIAN EXPRESS E 023		中国-东南亚	HONG KONG 香港 BANGKOK 曼谷	02/25(二) 03/02(三)	8	香港 曼谷
CMA-CGM 法国航程	CMA CGM GEMINI GMA498		中国-欧洲	XIAMEN 厦门 DURBAN 德班	02/25(二) 03/27(四)	30	厦门 德班
KLINE 川崎汽船	KYUNDAI PLATINUM M 004W		中国-中澳美	SHANGHAI 上海 PANAMA 巴拿马	02/25(二) 04/09(三)	43	上海 巴拿马
EMS 达飞轮船	COSCO KAOHSIUNG S/GFS46E		中国-澳新	HONG KONG 香港 NOUMEA 努美阿	02/25(二) 04/02(三)	36	香港 努美阿
RCL 地中海航运	ROTA PERMASAN VPM114		中国-中东/波斯湾-印度	QINGDAO 青岛 MADRAS 马德拉斯	02/26(三) 03/18(二)	18	青岛 马德拉斯
ZIM 以星轮船	KUD HUNG 311	CHINA_VIETNAM(CYK)	中国-东南亚	NINGBO 宁波 HONG KONG 香港	02/25(二) 03/15(六)	18	宁波 香港
SAFMARINE 比利牛斯航	HEINE P 1404		中国-非洲	KAOHSIUNG 高雄 MINDELO	02/25(二) 04/05(六)	39	高雄 明德洛
CEAY 长荣邮轮	CAP SAN NICOLA S/01409		中国-中澳美	SHANGHAI 上海 RIO GRANDE 里奥格兰德	02/25(二) 04/07(一)	41	上海 里奥格兰德
OOCL 东方海外	DRESDEN EXPRESS S/18808	Pacific Atlantic (PAX)	中国-澳新	SHANGHAI 上海 HALIFAX 哈利法克斯	02/25(二) 04/14(一)	48	上海 哈利法克斯

○
○

BEIJING	CN		BJ\$
Y. RENMINBI	CNY		KGS
BOSTON	1000000	1000000	1000000
		1000000	1000000
		1000000	1000000
		1000000	1000000
		1000000	1000000

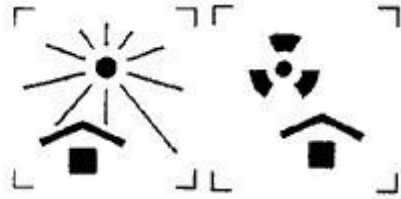
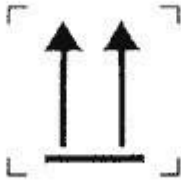
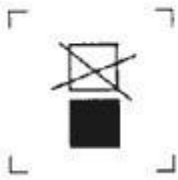

○

○

○

集装箱设备交接单
EQUIPMENT INTERCHANGE RECEIPT

OUT 出场

No.

用箱人/运箱人 (CNTR. USER/HAULIER)		提箱地点 (PLACE OF DELIVERY)
发往地点 (DELIVERED TO)	返回/收箱地点 (PLACE OF RETURN)	



--	--	--	--	--	--

--	--	--

--	--	--	--	--	--

--	--	--	--	--	--

--	--	--	--	--	--	--	--

○



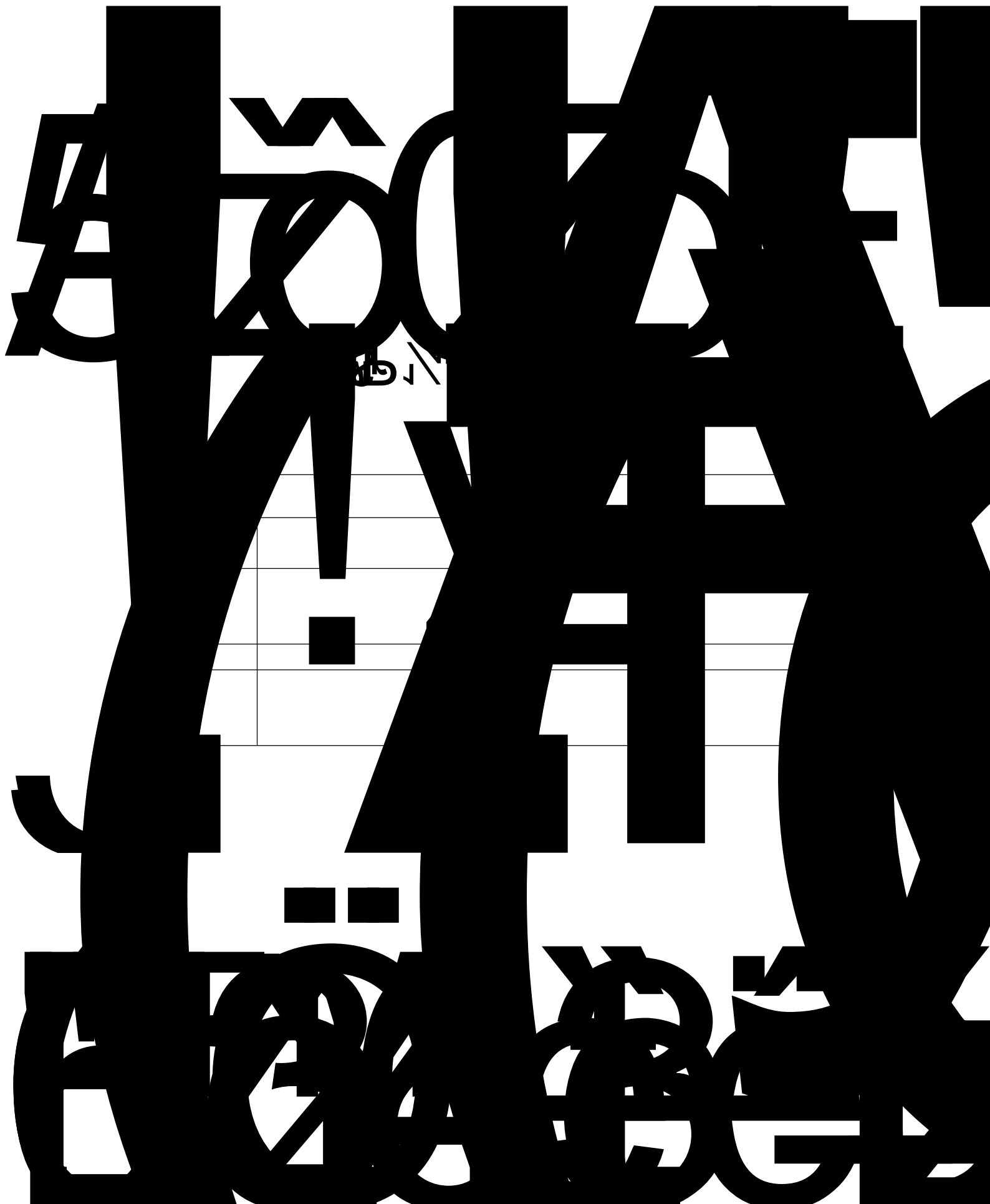

○

--	--	--

--	--	--	--	--	--

○

○

○

○

四、 快递物流作业组织与管理模块

--	--	--	--	--	--

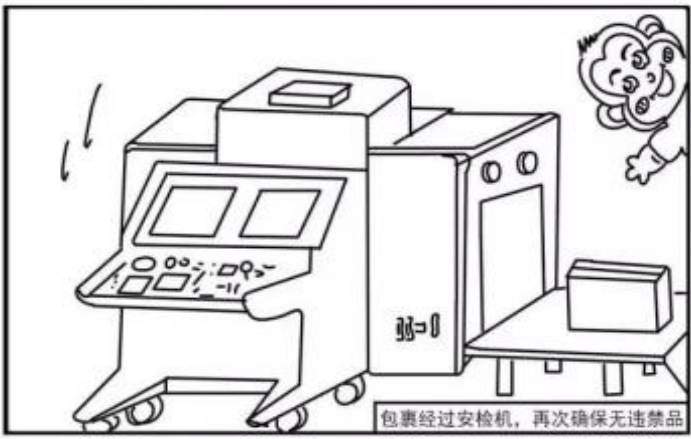

--	--	--	--	--	--

--	--	--	--	--	--

[想知道:中国成都理工大学校园快递具体在哪? 百度知道](#)

3个回答 - 提问时间: 2014年02月10日

最佳答案:韵达在银杏后面。宝盒、圆通、顺丰在电影院后面。中通、申通在图书馆下面。常用的是这几个。

[zhidao.baidu.com/link?... 2014-02-15](#) - 百度快照 - 80%好评

--	--	--	--

--	--	--	--

--

